

electrical service cover

SCALE 3:20

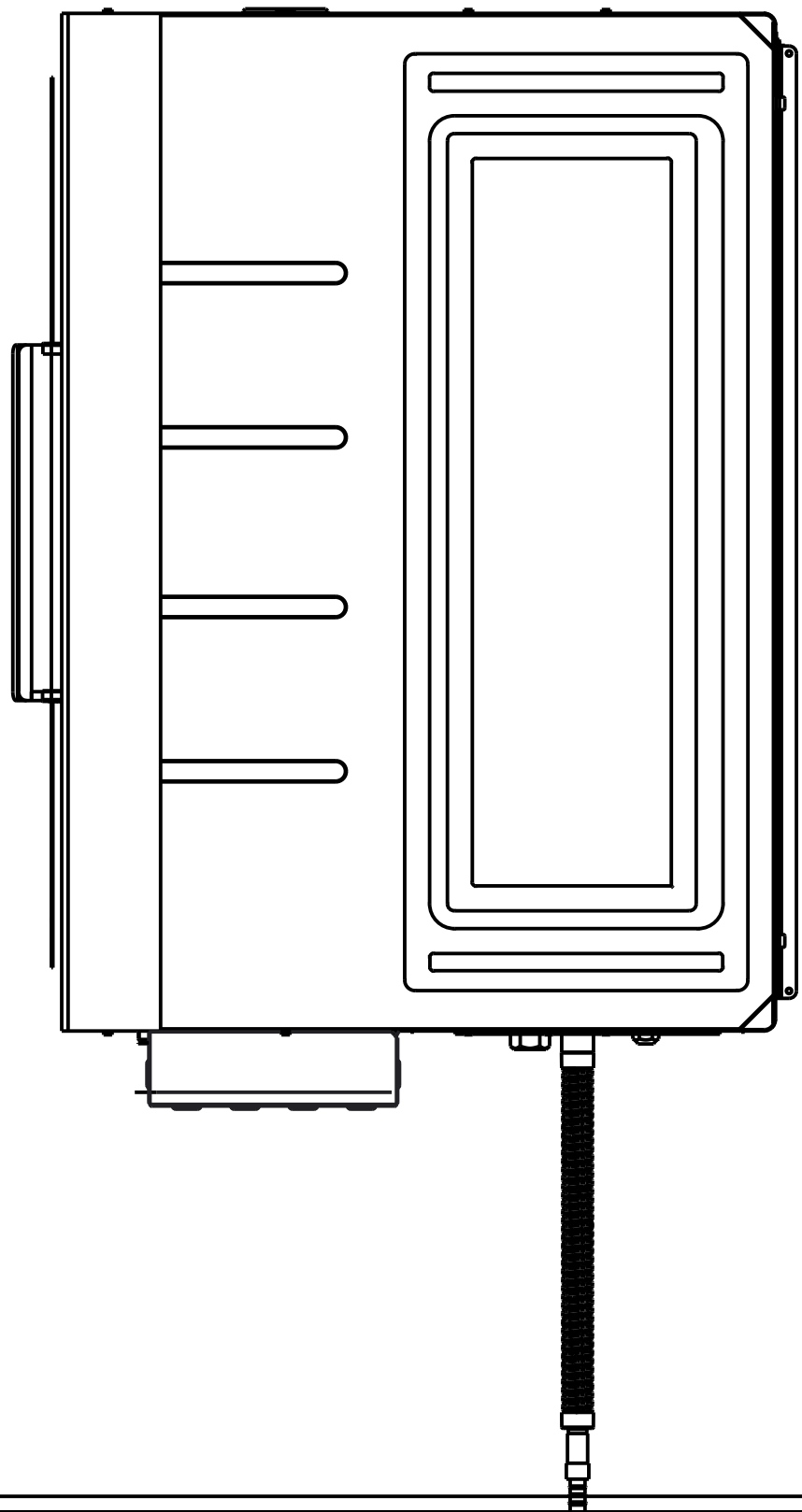

this indoor unit is for the models:
inviz wind 60/3